



WEDGEROCK

WORM GEARS

When Performance and Quality Matter



PRODUCTION



TRANSMISSION



WATER



POWER



MILITARY



Challenge WEDGEROCK with your application...we haven't found a torque, thrust or environment we can't handle.



wedge-rock.com | info@wedge-rock.com

WEDGEROCK Built For Performance

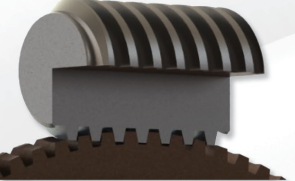

Cylindrical Worm
Minimal Teeth in Contact

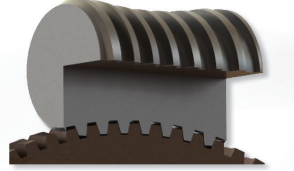

Double Enveloping WEDGEROCK Worm
2 to 3 Times More Teeth in Contact



Single Start Standard Efficiency
Worm Gear Inherently Self-Locking
Less Than 35% Efficient



Multi Start High Efficiency Worm Gear
Self-Locking Using Patented PolyLock Clutch
Greater Than 65% Efficient

Performance Comparison to Standard Worm Gear

Valve Size [in]	Torque w/ SF [in-Lbs.]	Handwheel Diameter [in]	Break Rim Pull [Lbs.]	Turns to Close		Reduction in Turns
				Conventional Competitor	WEDGEROCK Worm Gear	WEDGEROCK Worm Gear
24	180,000	36	< 80	154	73	2.2 X
30	325,000	36		226	79	2.9 X
36	475,000	36		305	120	2.6 X



Proof approved as is Not approved, changes noted above Note: Artwork changes made outside of original scope of work or quote will be billed at a standard hourly rate.

Item: _____ Date _____ Qty: _____ Print Name _____

The above signature acknowledges your request for our company to print and produce the above referenced item based on the artwork above. Also your signature means that all ARTWORK IS CORRECT and will be PRINTED EXACTLY AS SHOWN. We CANNOT be RESPONSIBLE for any changes once PROOF is SIGNED. By signing this proof form, you acknowledge that you have permission to use the artwork above and, if applicable, either own the copyright and/or trademark or are under license to use the artwork. You agree to indemnify, defend and hold our company harmless from any suit, demand, claim or liability arising from this warranty and shall pay costs and for any judgement or reasonable settlement that may arise from any possible copyright or trademark infringement. Proofs are emailed in color. Please call if you have any questions whatsoever.

WEDGEROCK: Better Design Better Materials

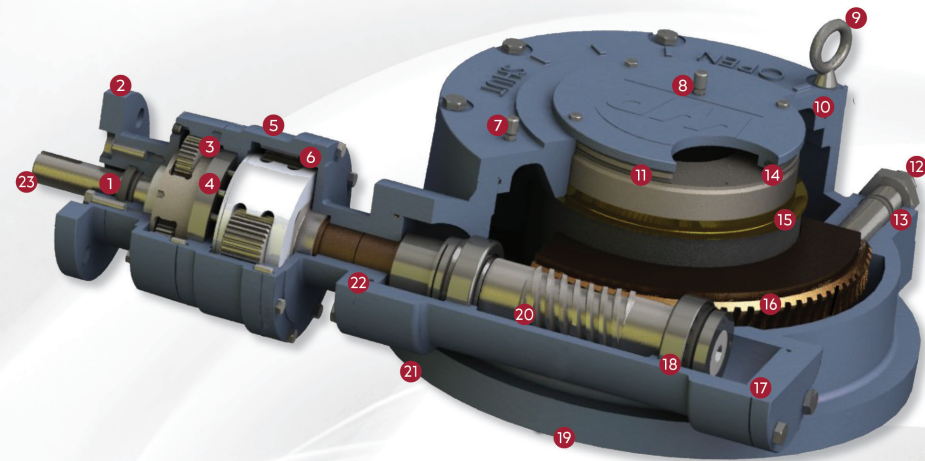

- | | |
|---------------------------------------|-------------------------------------|
| 1. Redundant Dynamic Seals | 13. Seal |
| 2. Manual or Motorized | 14. Seal |
| 3. Seal | 15. Bronze Bearing |
| 4. Self-Locking Mechanism | 16. Bronze Worm Gear |
| 5. Auxiliary Planetary Spur | 17. Seal |
| 6. Seal | 18. Roller Bearing |
| 7. Pressure Relief Vent | 19. Machined for Direct Mount |
| 8. Pressure Relief Vent | 20. Worm |
| 9. Lifting Eyes | 21. Ductile Iron Housing |
| 10. Seal | 22. Seal |
| 11. Redundant Dynamic Seals | 23. Corrosion Resistant Input Shaft |
| 12. Adjustable Stops from 80° to 100° | |

WEDGEROCK Benefits

- Standard Efficiency and High Efficiency
- Extends Size and Class of Manual Valves
- Fewer Turns to Close/Lower Input Torque
- External Anti-Back Drive - Configurable to Application
- Designed for Submerged Service - Surpasses IP68
- Nearly Zero Backlash for High Resolution Control

Standard Gear Operators from 5,000 in-lbs. to 16,000,000 in-lbs.

WEDGEROCK

When Performance and Quality Matter

OUR MISSION

WEDGEROCK provides performance engineered actuation solutions for demanding applications.

ABOUT WEDGEROCK



The WEDGEROCK name and logo symbolize the elegance of a simple and effective design and the grit, focus and determination required to make things happen – the work required to get big things moving. Pragmatism and hard work are central to our culture and reflected in everything we do.

Don't let our dirty hands and old school approach fool you. WEDGEROCK brings industry leading innovation to your engineered projects in standard lead times.

With a focused approach, WEDGEROCK provides solutions for the most demanding torque and thrust application. Whether you need to operate valves thousands of meters below the ocean surface, or a purpose designed gear operator for your valve line, give us a call or drop an email to get the partnership started.

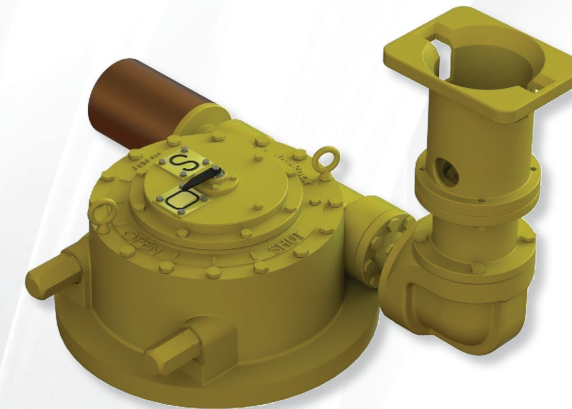

[207] 793.2289

34 Business Park Road | Limerick, Maine 04048 USA

wedgerock.com | info@wedgerock.com

Represented by:



435-654-3517

www.AVIROCKYMOUNTAIN.com