

efficiency vs safety ...
Why choose ?



**PORTABLE
VALVE
ACTUATORS
CATALOGUE**



modtec
portable valve actuators

WELCOME TO THE



moddec

WORLD



WATER

Moddec motors have been used for almost 30 years for many heavy duty applications, particularly in the chemical, petrochemical and automotive industries.



OIL & GAS

Our team's technical expertise and commercial flexibility enable us to develop and provide innovative, robust and powerful motors and solutions such as portable valve actuators, tapping machines and nut runners in a short and reliable time frame.



POWER PLANTS

Carefully assembled by our experienced workers in our factory based in Valence (South East of France), made of parts designed by our engineers and manufactured by thoroughly selected French and European suppliers, our products offer the highest quality standards.



MINING

Our technical team is at your disposal for any definition, design and realization of solution that will meet your specific needs and requirements.



PULP & PAPER

Welcome to a world of innovation, expertise and flexibility.
Welcome to the moddec world !



PETROCHEMICAL





Plug & Play

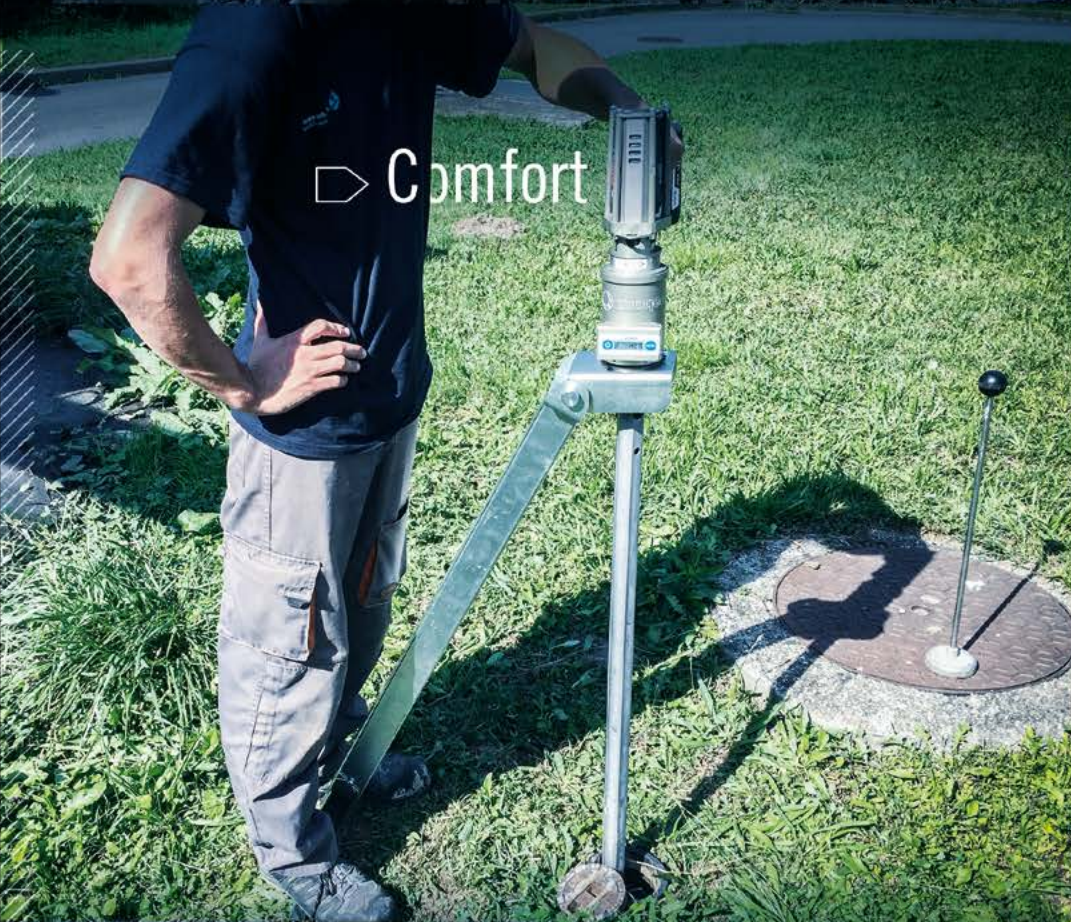

Comfort



Safety



Anywhere



Efficiency



ATEX



▷ A comprehensive
and modular range

1 CHOOSE YOUR POWER SUPPLY

PNEUMATIC

HL83



No heat, spark or smoke
ATEX certification available
High torque and speed
Light & compact
Jam & blockage resistant

Maximum torque :
1000 Nm (740 lb.ft)

GAS

PY68



Unlimited autonomy
Ideal for remote environments

Maximum torque :
1000 Nm (740 lb.ft)

BATTERY

JA73

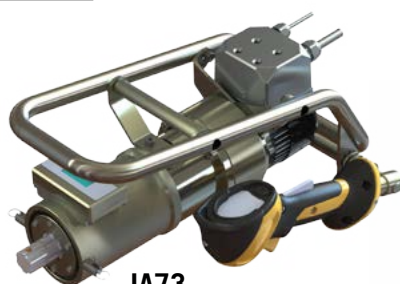

MC89



Excellent autonomy
Smoke free
Easy implementation

Maximum torque :
1000 Nm (740 lb.ft)

2 CHOOSE YOUR ACTUATOR'S HEAD

Unless otherwise stated, all heads are compatible with any actuator

STRAIGHT

For HL83 Easy and Standard duty only



RIGHT ANGLE

RA20

Note: Using the RA20 right angle head increases torque and decreases speed by 33% and is only possible with HL83 Easy and Standard duty.



RA30



BANJO

(for rising stem valves)

Standard Duty banjo head :
Multiplies the torque and divides the speed by 4



Heavy Duty banjo head :
Multiplies the torque and divides the speed by 3



3 CHOOSE YOUR ADAPTOR

STANDARD FIXED FINGERS ADAPTORS



SELF-ADJUSTING AND SELF-CENTERING FINGERS ADAPTORS



SPOKE ADAPTORS FOR FLAT HANDWHEELS



SPOKE ADAPTORS FOR TAPERED HANDWHEELS



FIXED UNIVERSAL ADAPTORS

(To be installed on the hand wheel)



SQUARE DRIVES FOR STANDARD SOCKETS



4 CHOOSE YOUR TORQUE REACTION MANAGEMENT SYSTEM

TORQUE REACTION ARM

(simple or double)



TELESCOPIC BIPOD



STAND FOR BURIED VALVES



ARTICULATED REACTION ARMS



FIXED FLANGES

(to be installed on the valve)

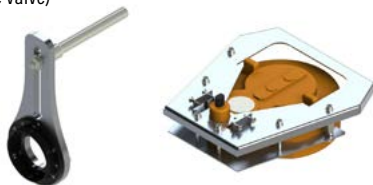

5 CHOOSE YOUR OPTIONS AND ACCESSORIES

REVOLUTION COUNTER

Digital display
Two ways rev. counter +
cumul and speed.
Memory



TORQUE LIMITER

Mechanical torque
limiter, manual re-engage
Adjustable torque limit



EXTENSION BARS AND UNIVERSAL JOINT

200 / 400 / 600 mm
(7.9 / 15.7 / 23.6 in)

Telescopic « Tee-key » for buried valve
Universal joints available



TRANSPORTATION AND STORAGE CASES

Protection case for
transport and storage
Convenient and sturdy
with foam prints inside



BATTERIES

Long-life battery
Backpack



«KIT BOX»

Complete and smart metal case
for professional use





REDUCTION RATIO

(1 to 3 digits)
see table overleaf

H L 8 3 X X X X X X

E = Easy duty
S = Standard duty
H = Heavy duty

OPTION

(2 digits)
see table overleaf

modtec pneumatic portable valve actuators are the most **compact, light** and **powerful**. They offer a wide choice in terms of power and **can be used in all environments**, even the very difficult ones.

You can have them **ATEX II 2 GD c IIC T6 to T4** certified, they can go to stall and they don't generate heat, sparks or smoke.

LAYOUT

HL83E

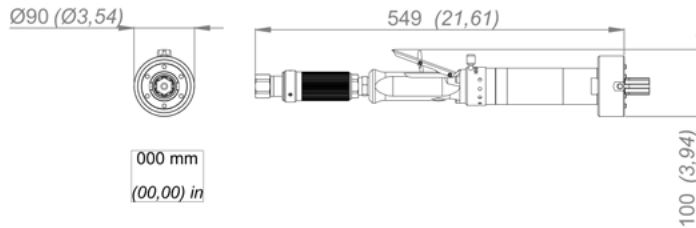

HL83S

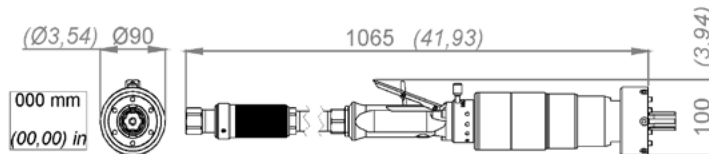

HL83H

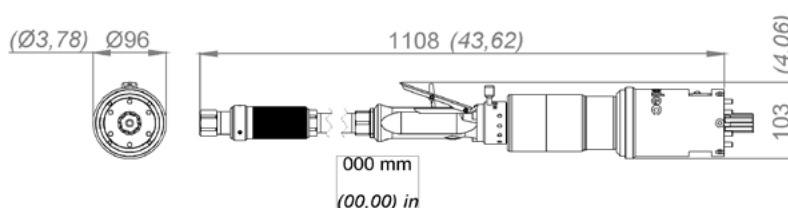

LAYOUT	Weight kg (lb)
HL83E	3,6 (7,9)
HL83S	6,5 (14,3)
HL83H	8,4 (18,5)

Watt → Horse power

W x 0,001341 = cv

Newton meter → Foot pound

Nm x 0,7376 = lb.ft

Millimeter → inch

mm x 0,03937 = in

Kv → Cv

Kv x 0,07 = Cv

Bar → pound / square inch

Bar x 14,5 = psi

Normo liter / minute → Standard cube feet / minute

NL / min x 0,03531 = scfm

Kilogramme → Pound

Kg x 2,205 = lb

OPTIONS AND ACCESSORIES

OPTIONS (page 5)						
Right-angled head RA20		▶			▶	
Digital revolution counter			▶			▶
Torque limiter*			▶	▶	▶	▶
CODE	00	01	02	03	04	05

*see torque and speed values page 5 : « Options »
 Not all options are available for all models.
 See below for availability.

! Check the technical data sheet to see which options and accessories are capable of withstanding the torque created by the actuator !

ACCESSORIES	Page
Drive head	6
Adaptors and interfaces	7-14
Torque reaction systems	15-17
Air management	18-19
Other accessories	20

CONNECTION AND LUBRICATION

CONNECTION & LUBRICATION	Air consumption Nl/min (scfm)	Connection	Minimum Ø for fittings mm (in)	Minimum Ø for pipes mm (in)	Lubrication Drops/min	FRL unit	SAT Box
HL83S/H	2000 (71)	G 3/4	8,2 (0,32)	12 (0,47)	6	AC107	AC118

Make sure you use a good quality FRL unit (Filtration, Pressure Regulation and Lubrication), capable of filtering air at 40µm.

PERFORMANCE

Straight or with RA30	Free speed (rpm)			Max torque (Nm (lb.ft))			Starting torque (Nm (lb.ft))			Options available				
	4 bars (58 psi)	5 bars (72 psi)	62 bars (90 psi)	4 bars (58 psi)	5 bars (72 psi)	62 bars (90 psi)	4 bars (58 psi)	5 bars (72 psi)	62 bars (90 psi)	01	02	03*	04*	05*
HL83E-023	500	530	560	13 (10)	17 (13)	21 (15)	10 (7)	14 (10)	17 (13)	▶				
HL83E-054	220	230	240	31 (23)	39 (29)	49 (36)	25 (18)	31 (23)	39 (29)	▶				
HL83S-035	230	250	270	100 (74)	120 (89)	145 (107)	80 (59)	96 (71)	116 (85)	▶	▶	▶	▶	▶
HL83S-060	130	140	150	170 (125)	200 (150)	250 (180)	130 (96)	160 (120)	200 (150)	▶	▶	▶	▶	▶
HL83H-111	70	76	83	250 (180)	300 (220)	370 (270)	230 (170)	280 (210)	350 (260)		▶	▶	▶	▶
HL83H-169	46	50	54	380 (280)	450 (330)	570 (420)	300 (220)	360 (270)	450 (330)		▶	▶	▶	▶
HL83H-321	24	26	29	720 (530)	860 (640)	1070 (790)**	670 (490)	810 (600)	1010 (750)**		▶	▶	▶	▶

With RA20 right angle head	Free speed (rpm)			Max torque (Nm (lb.ft))			Starting torque (Nm (lb.ft))			Options available				
	4 bars (58 psi)	5 bars (72 psi)	62 bars (90 psi)	4 bars (58 psi)	5 bars (72 psi)	62 bars (90 psi)	4 bars (58 psi)	5 bars (72 psi)	62 bars (90 psi)	01	02	03*	04*	05*
HL83E-023	380	400	420	18 (13)	22 (16)	28 (21)	14 (10)	18 (13)	22 (16)	▶				
HL83E-054	160	170	180	41 (30)	52 (38)	65 (48)	33 (24)	42 (31)	52 (38)	▶				
HL83S-035	170	180	190	120 (90)	160 (120)	190 (140)	96 (71)	130 (95)	150 (110)	▶			▶	
HL83S-060	100	105	115	220 (160)	270 (200)	330 (240)	175 (130)	215 (160)	265 (200)	▶			▶	
HL83H-111	Not available													
HL83H-169	Not available													
HL83H-321	Not available													

With banjo head BJH01	Free speed (rpm)			Max torque (Nm (lb.ft))			Starting torque (Nm (lb.ft))			Options available				
	4 bars (58 psi)	5 bars (72 psi)	62 bars (90 psi)	4 bars (58 psi)	5 bars (72 psi)	62 bars (90 psi)	4 bars (58 psi)	5 bars (72 psi)	62 bars (90 psi)	01	02	03*	04*	05*
HL83E-023	120	130	140	54 (40)	65 (48)	82 (60)	52 (38)	64 (47)	72 (53)					
HL83E-054	52	56	60	125 (92)	150 (110)	190 (140)	115 (84)	150 (110)	180 (130)					
HL83S-035	57	62	67	350 (260)	430 (320)	530 (390)	280 (210)	340 (250)	420 (310)		▶	▶		▶
HL83S-060	Not available													
HL83H-111	Not available													
HL83H-169	Not available													
HL83H-321	Not available													

With banjo head BJH02	Free speed (rpm)			Max torque (Nm (lb.ft))			Starting torque (Nm (lb.ft))			Options available				
	4 bars (58 psi)	5 bars (72 psi)	62 bars (90 psi)	4 bars (58 psi)	5 bars (72 psi)	62 bars (90 psi)	4 bars (58 psi)	5 bars (72 psi)	62 bars (90 psi)	01	02	03*	04*	05*
HL83E-023	160	170	180	40 (30)	49 (36)	62 (46)	32 (24)	39 (29)	50 (37)					
HL83E-054	70	75	80	95 (70)	115 (84)	145 (110)	76 (56)	92 (68)	115 (84)					
HL83S-035	75	82	90	260 (190)	320 (240)	400 (290)	210 (155)	260 (190)	320 (240)		▶	▶		▶
HL83S-060	44	48	52	450 (330)	550 (400)	680 (500)	360 (270)	440 (320)	540 (400)		▶	▶		▶
HL83H-111	23	25	28	750 (550)	900 (660)	1100 (810)**	690 (510)	840 (620)	1050 (770)**		▶	▶		▶
HL83H-169	Not available													
HL83H-321	Not available													

*see torque and speed values page 5 : « Options »

**Warning ! Do not use the actuator when the torque is higher than 1000 Nm (740 lb.ft) or use a torque limiter

IMPORTANT

For your comfort and safety, please carefully read the instruction manual before using the portable valve actuator.

GAS PORTABLE VALVE ACTUATORS PY68

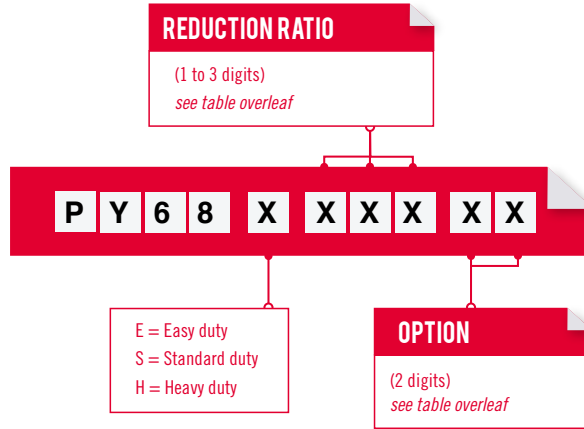

modtec gas portable valve actuators can be used in **total autonomy** – the only limit being the available petrol supply. They are particularly suitable for use in **isolated outdoor places**.

Extremely robust, they have an **integrated clutch system which protects the operator and the equipment**, even if a valve is completely blocked.

LAYOUT

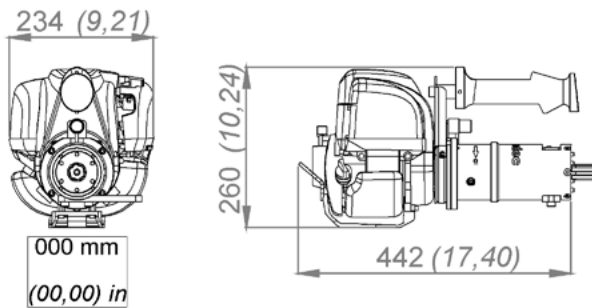

LAYOUT	Weight*(kg) (lb)
PY68E	10 (22)
PY68S	10,3 (22,7)
PY68H	10,3 (22,7)

*Empty weight
Gas tank capacity: 0.5 l (0.13 US gal)

Watt → Horse power W x 0,001341 = cv	Newton meter → Foot pound Nm x 0,7376 = lb.ft	Millimeter → inch mm x 0,03937 = in	Kv → Cv Kv x 0,07 = Cv
Bar → pound / square inch Bar x 14,5 = psi	Normo liter / minute → Standard cube feet / minute NL / min x 0,03531 = scfm	Kilogramme → Pound Kg x 2,205 = lb	

OPTIONS AND ACCESSORIES

OPTIONS (page 5)				
Digital revolution counter		▶		▶
Torque limiter*			▶	▶
CODE	00	02	03	05

*see torque and speed values page 5 : « Options »
 Not all options are available for all models.
 See below for availability.

! Check the technical data sheet to see which options and accessories are capable of withstanding the torque created by the actuator !

ACCESSORIES	Page
Drive head	6
Adaptors and interfaces	7-14
Torque reaction systems	15-17
Other accessories	20

PERFORMANCE

Straight or with RA30	Free speed (rpm)	Max torque (Nm (lb.ft))	Starting torque (Nm (lb.ft))	Options available		
				02	03*	05*
PY68E-031	305	55 (41)	41 (30)	▶	▶	▶
PY68S-087	100	150 (110)	115 (85)	▶	▶	▶
PY68S-148	64	260 (190)	195 (145)	▶	▶	▶
PY68H-192	50	340 (250)	250 (180)	▶	▶	▶
PY68H-293	32	520 (380)	390 (290)	▶	▶	▶
PY68H-641	15	1140 (840)**	850 (630)	▶	▶	▶

With banjo head BJH01	Free speed (rpm)	Max torque (Nm (lb.ft))	Starting torque (Nm (lb.ft))	Options available		
				02	03*	05*
PY68E-031	75	220 (160)	160 (120)	▶	▶	▶
PY68S-087	27	600 (440)	460 (340)	▶	▶	▶
PY68S-148	Not available					
PY68H-192						
PY68H-293						
PY68H-641						

With banjo head BJH02	Free speed (rpm)	Max torque (Nm (lb.ft))	Starting torque (Nm (lb.ft))	Options available		
				02	03*	05*
PY68E-031	100	165 (120)	120 (90)	▶	▶	▶
PY68S-087	36	460 (340)	350 (260)	▶	▶	▶
PY68S-148	21	790 (580)	590 (440)	▶	▶	▶
PY68H-192	16	1000 (740)**	760 (560)	▶	▶	▶
PY68H-293	Not available					
PY68H-641						



*see torque and speed values page 5 : « Options »

** Warning ! Do not use the actuator when the torque is higher than 1000 Nm (740 lb.ft) or use a torque limiter

IMPORTANT

For your comfort and safety, please carefully read the instruction manual before using the portable valve actuator.

ELECTRIC PORTABLE VALVE ACTUATORS MC89

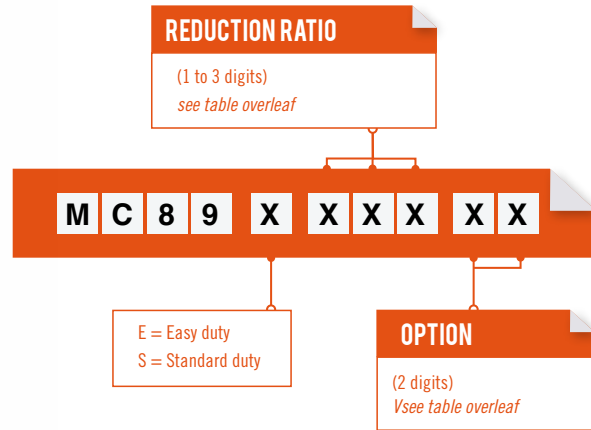

Although it is **super light and compact**, the MC89 Portable Valves Actuator delivers a 850 Nm (620 lb.ft) maximum torque. This makes it the perfect tool for any « **Easy** » or « **Standard** » duty job, for any valve type, indoor or outdoor, with a great autonomy. Its two **18V Lithium-Ion batteries** allow to use it continuously during **up to one hour**. For an even more intensive usage, use the **main power connection kit** that plugs on the actuator just like a battery and provides an **unlimited autonomy**.

Designed for any type of operation, the MC89 comes with 3 models only that cover a **0 to 450 rpm speed** range and a **850 Nm maximum torque**. No need to say that even the most stubborn valves can be operated! No worry though, the **integrated electronic torque limiter** will easily prevent any damages for your valve or the tool itself.

LAYOUT

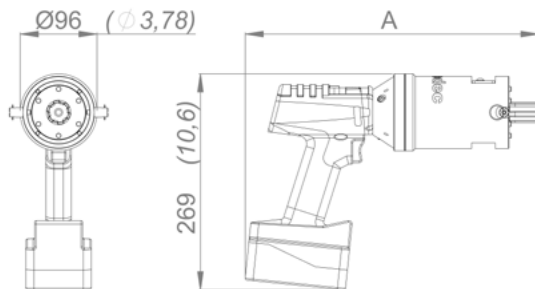

LAYOUT	Weight (kg)	Length "A" (mm / in)
MC89E - 007	5,1	354 (13.9)
MC89S - 035	5,1	354 (13.9)
MC89S - 054	5,4	367 (14.4)
Battery	0,7	

Watt → Horse power

W x 0,001341 = cv

Newton meter → Foot pound

Nm x 0,7376 = lb.ft

Millimeter → inch

mm x 0,03937 = in

Kv → Cv

Kv x 0,07 = Cv

Bar → pound / square inch

Bar x 14,5 = psi

Normo liter / minute → Standard cube feet / minute

NL / min x 0,03531 = scfm

Kilogramme → Pound

Kg x 2,205 = lb

BATTERIES AND CHARGERS

Batteries technical data	BAT150
Voltage	18V
Capacity	5,20 Ah
Autonomy*	24 mn
Charging times with standard charger BAT145	45 mn
Charging times with quick charger BAT146	33 mn
Weight (kg)	0,7 kg



Charger technical data	BAT152	BAT153
Power supply (input)	120V	
Mains frequency	60 Hz	
Charging voltage (output)	10,8 - 18 V DC	
Quick charging	Max 6A	Max 8A
Charging temperature range	-5 à +55°C	
Safety class	II	
Weight (kg)	0,8 kg	1,1 kg



*Autonomy measured at 50% of the maximum load

The main power connection kit (ref BAT147) connects any main power plug to the actuator (in place of the battery) and provides an unlimited autonomy.

SPEED CONTROLLER & ELECTRONIC TORQUE LIMITER

The MC89 comes with an embedded **speed control and torque limiter electronic system** for an optimal **people and material protection** as well as a **perfect adaptation** to different constraints and environments. By adjusting the speed control trigger (4 positions) and the max torque scroll wheel

(13 positions), you can set the required torque limit and / or rotation speed. When reaching the torque limit, the actuator will stop and sound a beep. The speed control trigger allows to set 4 different speeds and for each of these speeds, the torque scroll wheel allows to set 13 different torque limits.



OPTIONS AND ACCESSORIES

OPTIONS (page 5)		
Digital revolution counter		▶
CODE	00	02

! Check the technical data sheet to see which options and accessories are capable of withstanding the torque created by the actuator !

ACCESSORIES	Page
Drive head	6
Adaptors and interfaces	7-14
Torque reaction systems	15-17
Other accessories	20

PERFORMANCE

Straight or with RA30	Free speed (rpm)	Max torque (Nm (lb.ft))	Options available
			02
MC89E-007	450	115 (85)	▶
MC89S-035	94	550 (400)	▶
MC89S-054	61	850* (630)*	▶



Warning !

Do not use the RA30 right angle head when the torque is higher than 600 Nm (440 lb.ft) or set the torque limit to 600 Nm before use. Read user's manual for more information.

With banjo head BJH01	Free speed (rpm)	Max torque (Nm (lb.ft))
MC89E-007	113	460 (340)
MC89S-035	24	600* (440)*
MC89S-054	14	600* (440)*

* Warning ! The maximum acceptable torque for the BJH01 is 600 Nm (440 lb.ft). Do not use the BJH01 if the torque required is higher than 600 Nm (440 lb.ft), use the torque limiter to limit the input torque to 150 Nm (110 lb.ft) (see stickers on the actuator and table hereafter).



With banjo head BJH02	Free speed (rpm)	Max torque (Nm (lb.ft))
MC89E-007	150	350 (260)
MC89S-035	31	1000* (740)*
MC89S-054	20	1000* (740)*

* Warning ! The maximum acceptable torque for the BJH02 is 1000 Nm (740 lb.ft). Do not use the BJH02 if the torque required is higher than 1000 Nm (740 lb.ft), use the torque limiter to limit the input torque to 330 Nm (240 lb.ft) (see stickers on the actuator and table hereafter).



IMPORTANT

For your comfort and safety, please carefully read the instruction manual before using the portable valve actuator.

ELECTRIC PORTABLE VALVE ACTUATORS JA73

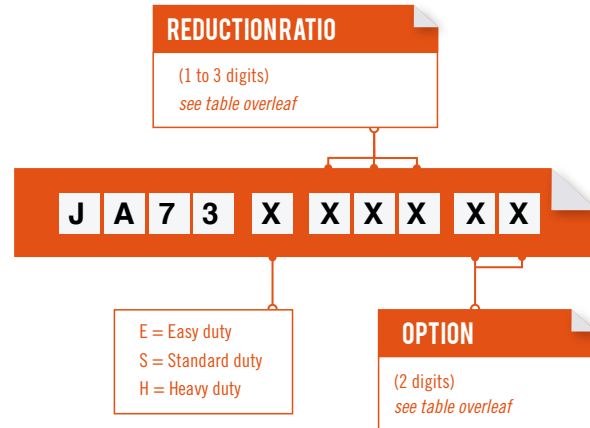

Dedicated to the most demanding applications!

Thanks to its **robustness** and high autonomy batteries, the **JA73 modtec electric portable valve actuator** is able to deliver a **high power** for **more than one hour** continuously. It does not depend on any energy source (electric plug or compressed air network) and can operate freely anywhere. Much more **powerful** than its little brother (MC89), it can deliver **high speed** and **high torque** simultaneously, which makes it **the perfect tool for Heavy duty jobs**. Extremely robust, it has got an **integrated clutch system** which protects the operator and the equipment, even if a valve is completely blocked.

The **ergonomic control handle** allows the display and control of the many actuator and battery's functions and parameters in a **simple and intuitive way**.

The **integrated electronic torque limiter** (available as standard on all models) allows to adapt to any configuration and further improve the **safety of the user and the equipment**.

LAYOUT

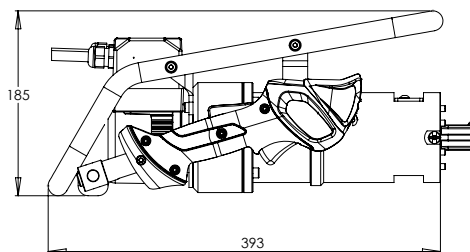
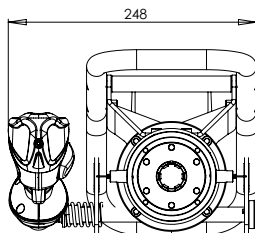

Weight : 8.7 kg
(62.9 lb.ft)

Watt → Horse power W x 0,001341 = cv	Newton meter → Foot pound Nm x 0,7376 = lb.ft	Millimeter → inch mm x 0,03937 = in	Kv → Cv Kv x 0,07 = Cv
Bar → pound / square inch Bar x 14,5 = psi	Normo liter / minute → Standard cube feet / minute NL / min x 0,03531 = scfm	Kilogramme → Pound Kg x 2,205 = lb	

BATTERIES

Technical data	BAT520	BAT750	BAT1200	BAT1500
Type	Li-ion	Li-ion	Li-ion	Li-ion
Output voltage	43.2 V	43.2 V	43.62 V	43.62 V
Capacity	12 Ah	17.25 Ah	28 Ah	35 Ah
Stored energy	520 Wh	745 Wh	1221 Wh	1527 Wh
Maximum power	2 kW	2 kW	2 kW	2 kW
Autonomy*	25 min	35 min	60 min	90 min
Charging time	6h30	9h	10h	12h
Average life (number of cycles)*	up to 800	up to 1200	up to 1300	up to 1300
Weight (kg (lb))	3,6 (26)	4,5 (32.5)	6,3 (45.5)	7,5 (54.2)



The electric portable actuators use high performance batteries for greater autonomy. Both battery and charger need to be ordered separately. These batteries come with a light, comfortable harness for use during transport or when using the actuator.

* Autonomy is measured for an equivalent torque of 50% of maximum torque.

** One cycle means one complete battery charge and discharge.

OPTIONS AND ACCESSORIES

OPTIONS (page 5)

Digital revolution counter	<input type="checkbox"/>	<input type="checkbox"/>
CODE	00	02



Check the technical data sheet to see which options and accessories are capable of withstanding the torque created by the actuator !

ACCESSORIES

ACCESSORIES	Page
Drive head	6
Adaptors and interfaces	7-14
Torque reaction systems	15-17
Other accessories	20

PERFORMANCE

Straight or with RA30	Free speed (rpm)	Max torque (Nm (lb.ft))	Starting torque (Nm (lb.ft))	Options available
				02
JA73E-023	360	44 (32)	35 (26)	<input type="checkbox"/>
JA73S-077	110	150 (110)	120 (89)	<input type="checkbox"/>
JA73S-132	63	250 (180)	200 (150)	<input type="checkbox"/>
JA73H-169	49	325 (240)	260 (190)	<input type="checkbox"/>
JA73H-309	27	590 (435)	470 (350)	<input type="checkbox"/>
JA73H-564	15	1080* (800)*	860 (640)	<input type="checkbox"/>
With banjo head BJH01	Free speed (rpm)	Max torque (Nm (lb.ft))	Starting torque (Nm (lb.ft))	Options available
				02
JA73E-023	90	180 (130)	140 (100)	<input type="checkbox"/>
JA73S-077	27	590 (435)	470 (350)	<input type="checkbox"/>
JA73S-132	non disponible			
JA73H-169	non disponible			
JA73H-309	non disponible			
JA73H-564	non disponible			
With banjo head BJH02	Free speed (rpm)	Max torque (Nm (lb.ft))	Starting torque (Nm (lb.ft))	Options available
				02
JA73E-023	120	135 (100)	105 (77)	<input type="checkbox"/>
JA73S-077	36	440 (320)	350 (260)	<input type="checkbox"/>
JA73S-132	21	760 (560)	600 (440)	<input type="checkbox"/>
JA73H-169	16	975 (720)	780 (580)	<input type="checkbox"/>
JA73H-309	non disponible			
JA73H-564	non disponible			



* Warning ! Do not use the actuator when the torque is higher than 1000 Nm (740 lb.ft) or use a torque limiter

Some electric portable actuator manufacturers give torque and speed performance without reference to the length of operating time. This can suggest a high performance level when in reality the level can only be achieved for a few seconds and with significant risk of damage to the actuator's motor. Portable actuators using a modéc battery are designed and tested to deliver the stated performance level with no time limit other than the length of the battery life.

IMPORTANT

For your comfort and safety, please carefully read the instruction manual before using the portable valve actuator.

OPTIONS

Options are built into the actuator during factory assembly and cannot be added or removed at a later stage.

▶ RIGHT-ANGLE HEAD RA20



Only available for the HL83 Easy duty and Standard duty range, the **right angle head RA20** is very light and compact.

It enables the actuator to operate in small, tight spaces.

It adds a reduction ratio of 1.33 to the tool, thus **increasing the torque and reducing the speed by one third**.

Maximum torque allowed: 330Nm

▶ DIGITAL REVOLUTION-COUNTER



The **digital revolution counter** adds up the turns in one direction and subtracts them in the other direction so that the operator always knows where he is in relation to the starting point. **It also measures and indicates the rotating speed**.

It can be **easily configured** to adapt to the different actuator heads available (right angle or ring-type).

Not available for the **HL83E** models.

▶ TORQUE LIMITER



The **torque limiter** for modtec portable valve actuators means you can disconnect the motor section from the gear box section when the torque limit is reached. No torque is thereafter applied by the actuator.

The **operator can set the torque limit** within a +/- 40% range of the original value. The torque limiter option is available for the HL83S and H models, as well as for the PY68 models (the JA73 and MC89 models have an electronic torque limiter in series).

Straight or with RA30 right angle head	Reduction ratio	Free speed @ 6,2 bars (rpm)	Minimum torque limit Nm(lb.ft)	Maximum torque limit Nm(lb.ft)
HL83S-035-03/05	1:54	175	40 (30)	90 (66)
HL83S-060-03/05	1:127	71	90 (66)	220 (160)
HL83H-111-03/05	1:199	46	140 (100)	340 (250)
HL83H-169-03/05	1:258	54	180 (130)	440 (320)
HL83H-321-03/05	1:564	25	400 (300)	960 (710)
PY68E-031-03/05	1:31	305	20 (15)	45 (33)
PY68S-087-03/05	1:40	218	25 (18)	60 (44)
PY68S-148-03/05	1:61	155	40 (30)	90 (66)
PY68H-192-03/05	1:192	50	120 (90)	280 (210)
PY68H-293-03/05	1:293	32	180 (130)	440 (320)
PY68H-641-03/05	1:564	25	400 (300)	960 (710)

With RA20 right angle head	Reduction ratio	Free speed @ 6,2 bars (rpm)	Minimum torque limit Nm(lb.ft)	Maximum torque limit Nm(lb.ft)
HL83S-035-04	1:74	132	50 (37)	120 (90)

With banjo head BJH01	Reduction ratio	Free speed @ 6,2 bars (rpm)	Minimum torque limit Nm(lb.ft)	Maximum torque limit Nm(lb.ft)
HL83S-035-03/05	1:216	44	160 (120)	360 (270)
HL83S-060-03/05	1:504	18	360 (270)	880 (650)*
PY68E-031-03/05	1:124	76	80 (59)	180 (130)
PY68S-087-03/05	1:160	54	100 (74)	240 (180)
PY68S-148-03/05	1:244	39	160 (120)	360 (270)

* Do not use the BJH01 with a maximum torque higher than 600 Nm (440 lb.ft)

With banjo head BJH02	Reduction ratio	Free speed @ 6,2 bars (rpm)	Minimum torque limit Nm(lb.ft)	Maximum torque limit Nm(lb.ft)
HL83S-035-03/05	1:162	58	120 (89)	270 (200)
HL83S-060-03/05	1:381	24	270 (200)	660 (490)
HL83H-111-03/05	1:597	15	420 (310)	1020 (750)*
HL83H-169-03/05	1:774	18	540 (400)	1320 (970)*
PY68E-031-03/05	1:93	102	60 (44)	135 (100)
PY68S-087-03/05	1:120	73	75 (55)	180 (130)
PY68S-148-03/05	1:183	52	120 (89)	270 (200)
PY68H-192-03/05	1:576	17	360 (270)	840 (620)
PY68H-293-03/05	1:879	11	540 (400)	1320 (970)*

* Do not use the BJH02 with a maximum torque higher than 1000 Nm (740 lb.ft)

IMPORTANT

For your comfort and safety, please carefully read the instruction manual before using the portable valve actuator.

ACTUATOR'S DRIVE HEADS

The actuator heads are compatible with all **modec** portable valve actuators.

STANDARD DUTY RING-TYPE DRIVE HEAD (“BANJO HEAD”)



Maximum allowed torque: 600 Nm (440 lb.ft)
Weight: 5kg (11 lb)

Essential for all **rising stem handwheels**, the **Standard duty banjo drive head** caters for all stems up to a **maximum diameter of 63mm (2.48”)**. It can also operate all clamping systems for handwheel and other interfaces. What's more, it brings additional reduction which means you can **multiply the actuator's torque by 4** and reduce the speed by the same factor. **Perfect for difficult or stiff handwheels.**

With a **maximum torque of 600 Nm (440 lb.ft)**, the Standard duty banjo head can be mounted quickly and easily on all **Easy duty actuators** and on some **Standard duty actuators** (see product files).

Reference : **BJH01**

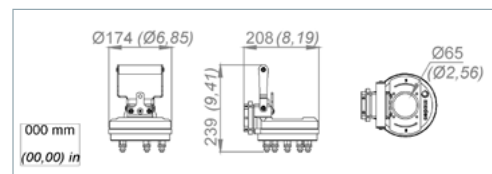

HEAVY DUTY RING-TYPE DRIVE HEAD (“BANJO HEAD”)



Maximum allowed torque: 1000 Nm (740 lb.ft)
Weight: 8.6kg (19 lb)

The **Heavy duty banjo drive head** should be used for **very high torques**. It caters for **rising stems up to a maximum diameter of 70mm (2.75”)** and is compatible with all clamping systems for handwheel and other interfaces. It brings additional reduction which means you can **multiply the actuator's torque by 3** and reduce the speed by the same factor.

With a **maximum torque of 1000 Nm (740 lb.ft)**, the Heavy duty banjo head can be mounted quickly and easily on **all Easy and Standard duty actuators, as well as some Heavy duty ones** (see product files).

Reference : **BJH02**

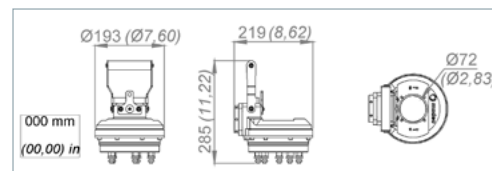

RIGHT-ANGLE DRIVE HEAD RA30



Maximum allowed torque : 600 Nm (465 lb.ft)
Weight : 4.2 kg (9.3 lb)

The RA30 right angle drive head can be positioned at 90° to the actuator providing **optimal positioning for the operator**.

It is suitable for **high torques** (up to 600 Nm (465 lb.ft)).

The right angle drive head RA30 can be mounted quickly and easily on all our actuators. It brings no change in the speed and the torque as the reduction ratio is 1:1.

Reference : **RA30**

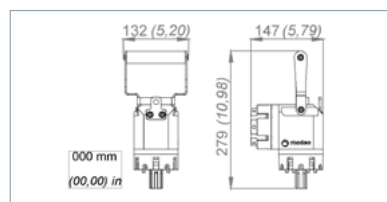

IMPORTANT

For your comfort and safety, please carefully read the instruction manual before using the portable valve actuator.

FINGERS TYPE ADAPTORS

This **exclusive patented system** is the **simplest** and **most effective** for clamping on to **flat or slightly tapered handwheels**.

No need to pre-install drive plates on the handwheel before use. The fingers type adaptors fix simply on to the portable actuator head, and can then be used to turn every handwheel that has the same number of spokes. It takes less than a minute to change the adaptor. It can also be used for rising stem valves (if used with a banjo head).

These adaptors **save a significant amount of time and money** as there's no need to buy and install a drive plate for each handwheel.

FIXED FINGERS ADAPTORS (SUAxxx)

The fixed fingers adaptors should be used for **flat or slightly tapered handwheels** (spokes at an angle < 30° in relation to the wheel's plane) and are composed of a **drive plate** on which one can screw up to **7 removable fingers** according to the number of spokes on the handwheel you want to turn.

If used with a **banjo head**, fingers can also be screwed directly on to the head (maximum 5 fingers in that case), leaving space for the **rising stem** to pass through. If used with a **straight or right angle head**, the **KPA004 interface** is required to fix the drive plate on to the actuator head (see technical sheet 12).

For **small diameters** handwheels, one can use the standard drive plate and place three or four fingers on the small diameter (150 mm) or use the **SUA034** drive plate with shorter and smaller fingers placed on a 75 mm diameter.

FINGERS USED DIRECTLY ON A BANJO HEAD :



3 X SUA001 FIXED ON THE BANJO HEAD



4 X SUA001 FIXED ON THE BANJO HEAD



5 X SUA001 FIXED ON THE BANJO HEAD

FINGERS USED ON A DRIVE PLATE :

Requires KPA004 interface with a straight or right angle drive head

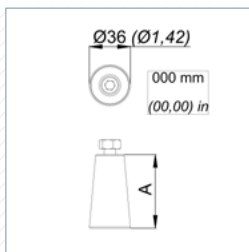

SUA001/ SUA901
(FINGER FOR BJH OR SUA002)

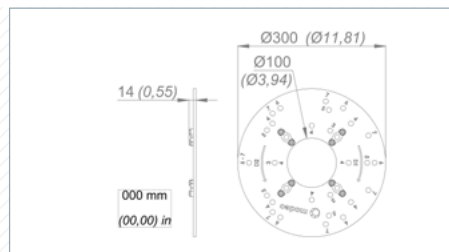

SUA002 (300 MM DRIVE PLATE)

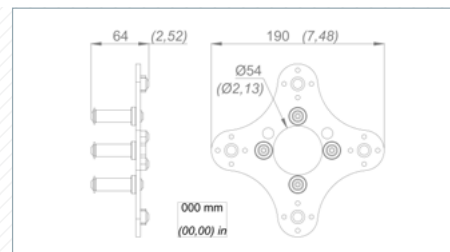

SUA034 (190 MM DRIVE PLATE)

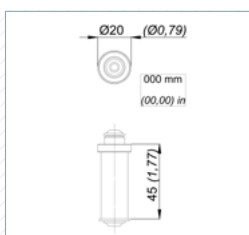

SUA801 (SINGLE FINGER FOR
SUA034 DRIVE PLATE)



SUA007
(1 DRIVE PLATE + 7 FINGERS)



SUA034
(1 DRIVE PLATE + 4 FINGERS)

	Weight kg (lb)	«A» mm (in)	Max torque Nm (lb.ft)
SUA001	0,3 (0,7)	65	3 fingers: 350 (260)
SUA901	0,2 (0,4)	45	4 to 7 fingers: 1000 (740)
SUA002	2,5 (5,5)	N/A	
SUA801	0,1 (0,2)	45	3 or 4 fingers:
SUA034	0,8 (1,8)	N/A	150 (110)
SUA007	5,2 (11,5)	N/A	1000 (740)

IMPORTANT

For your comfort and safety, please carefully read the instruction manual before using the portable valve actuator.

ADAPTORS

2/5

SELF-ADJUSTING AND SELF-CENTERING FINGERS ADAPTORS (SAxxx)



Thanks to its **patented system**, these adaptors clamp instantly on to the handwheel and **the actuator automatically centres itself giving greater ease and efficiency.**

This adaptor should be selected for **flat or slightly tapered handwheels** (spokes at an angle of $< 10^\circ$ in relation to the wheel's plane). It fixes directly on to the banjo head, and via a **KPA003, KPA004 or KPA005** interface on the standard splined shaft of the **straight and right angle actuators** (see technical sheet 12). To **avoid scratching the handwheel**, use the protector **SA103/104/105/106/107** (see technical sheet 12).

These adaptors **save a significant amount of time and money** as there's no need to buy and install a drive plate for each handwheel.



SA003



SA004

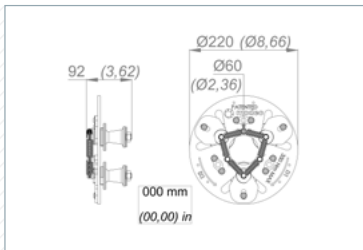

FOR 3 OR 6 SPOKES HANDWHEELS

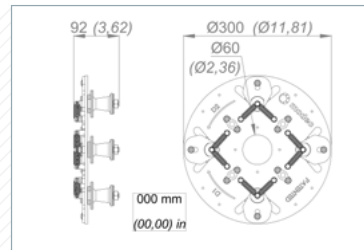

FOR 2 OR 4 SPOKES HANDWHEELS

	Weight kg (lb)	Max torque Nm (lb.ft)	Interface for straight or right angle head
SA003	2,3	350	KPA003
SA004	4,1	1000	KPA004
SA005	4,4	1000	KPA005
SA006	5,6	1000	KPA005
SA007	5,9	1000	KPA005



SA005



SA006



SA007

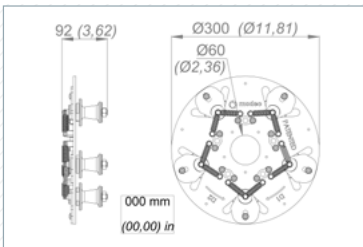

FOR 5 SPOKES HANDWHEELS

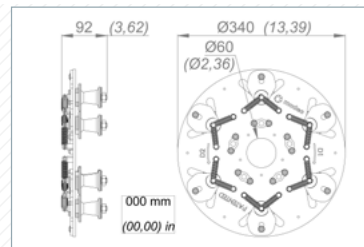

FOR 6 SPOKES HANDWHEELS

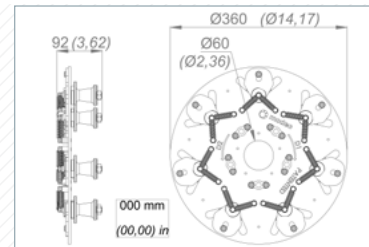

FOR 7 SPOKES HANDWHEELS

IMPORTANT

For your comfort and safety, please carefully read the instruction manual before using the portable valve actuator.

► SPOKE ADAPTORS

The **spoke adaptors** clamp **solidly** and **quickly** to the handwheel and can turn in both directions, **with or without a rising** stem. It is available in two versions – one that adapts to flat or slightly tapered (< 30°) handwheels; a second for tapered handwheels (> 30°).

The adaptor has a strong hold on the handwheel and also fixes firmly to the actuator, providing complete **safety** during manoeuvres, even in difficult positions.

These adaptors **save a significant amount of time and money** as there's no need to buy and install a drive plate for each handwheel.

► SPOKE ADAPTORS FOR FLAT HANDWHEELS (FSB)

These adaptors should be used for **flat or slightly tapered handwheels** (spokes at an angle < 30° in relation to the wheel's plane).

A choice of two models are available according to the **number of spokes** in the handwheel you want to turn.

These adaptors can be used with a **straight or right angle actuator** using the **KTA002** interface, and with a **banjo head** in conjunction with the **TTA002** (see technical sheet 14).



FSB245

For 2, 4 or 5 spokes handwheels



FSB356

For 3, 5 or 6 spokes handwheels

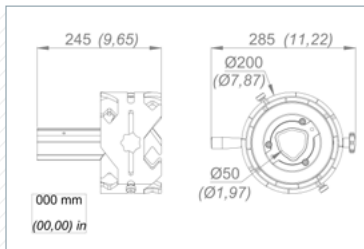

Weight : 5.2 kg (11.5 lb)
Maximum allowed torque: 1000 Nm (740 lb.ft)

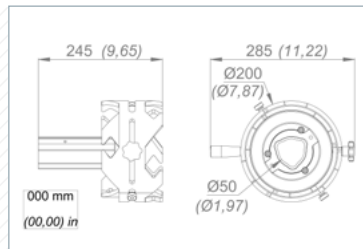

FSB adaptors require the KTA002 interface with a straight or right angle drive head, and the TTA002 interface with a banjo head.

IMPORTANT

For your comfort and safety, please carefully read the instruction manual before using the portable valve actuator.

ADAPTORS

4/5

► SPOKE ADAPTORS FOR TAPERED HANDWHEELS (CSB)

These adaptors should be used for **tapered handwheels** with spokes at an angle greater than 30° in relation to the wheel's plane. A choice of three models are available according to **the number of spokes in the handwheel you want to turn**.

These adaptors can be used with a **straight or right angle actuator** due to the **KTA002**, and with a **banjo head** in conjunction with the **TTA002 interface** (see technical sheet 14).

These adaptors **save a significant amount of time and money** as there's no need to buy and install a drive plate for each handwheel.



CSB003



CSB004



CSB005

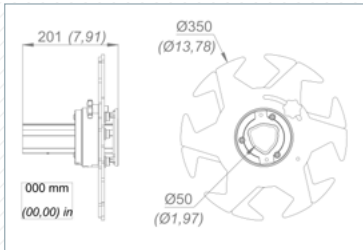

FOR 3 OR 6 SPOKES HANDWHEELS

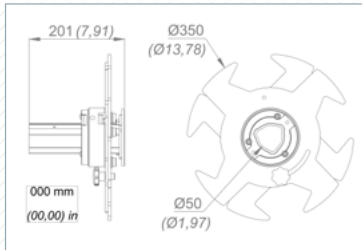

FOR 2 OR 4 SPOKES HANDWHEELS

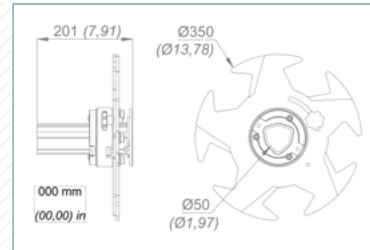

FOR 5 SPOKES HANDWHEELS

Maximum allowed torque: 1000 Nm (740 lb.ft)
Weight : 4.2 kg



CSB adaptors require the KTA002 interface with a straight or right angle drive head, and the TTA002 interface with a banjo head.

IMPORTANT

For your comfort and safety, please carefully read the instruction manual before using the portable valve actuator.

► FIXED UNIVERSAL ADAPTORS (FUAxxx)

These adaptors must be **fixed to the handwheel before use**. Thanks to their multiple "U" clamps that catch the handwheel's spokes, they can fix on to almost every type of handwheel.

The FUA adaptor is available in 4 versions for flat or tapered handwheels: **FUA001** (or **FUA316** for stainless steel version) for **flat or slightly tapered handwheels** with spokes inclined up to 30° in relation to the wheel's plane; **FUA002** (or **FUA317** for stainless steel version) for **tapered handwheels** with spokes inclined from 30° to 40° in relation to the wheel's plane.

These drive plate adaptors can be used **directly on a banjo head**. To use them with a **straight or right angle head**, you need to use the **KPA004 interface** (see technical sheet 12). They can also be used with **EBx04 extension bars** using the interface **TTA** (see technical sheet 13).



FUA001 FOR FLAT OR SLIGHTLY TAPERED HANDWHEELS (<30°)



FUA002 FOR TAPERED HANDWHEELS (30° TO 40°)

	«A» mm (in)	Weight kg (lb)
FUA001	45 (1,77)	3,1 (6,8)
FUA002	65 (2,56)	3,3 (7,3)

Maximum allowed torque: 1000 Nm (740 lb.ft)

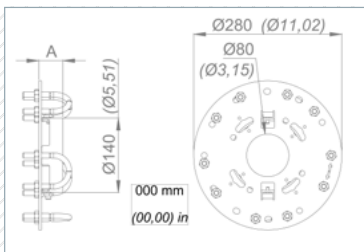

Requires KPA004 interface
(or KPA316 for stainless steel
version) with a straight or right
angle drive head

IMPORTANT

For your comfort and safety, please carefully read the instruction manual before using the portable valve actuator.

Thanks to the various interfaces, the adaptors can be used with any portable valve actuator and any head (straight, right angle or banjo). They also enable you to use the actuators for applications other than activating valves and on many types of interface other than handwheels.

INTERFACES FOR ADAPTORS SAXXX, SUAxxx AND FUAxxx WITHOUT A BANJO HEAD

Using the **KPA** interface, you can manipulate the **SAXxx**, **SUAxxx** and **FUAxxx** adaptors without a banjo head. Please note, this configuration is not compatible with handwheels that have a rising stem.

The KPA interface is available in 3 versions:

KPA003 for the SA003 adaptor

KPA004 (or KPA316 stainless steel) for the SA004, SUA and FUA adaptors

KPA005 for the SA005, SA006 and SA007 adaptors

Reference	Weight kg (lb)	Max torque Nm (lb.ft)
KPA003	0.6 (1,3)	350 (260)
KPA004	0.8 (1,8)	1000 (740)
KPA005	0.7 (1,5)	1000 (740)



HANDWHEEL PROTECTORS FOR USE WITH SAXxx ADAPTORS

These protectors, integrated into the self-adjusting and self-centering fingers adaptors (SAXxx), are designed to **protect the handwheel from being scratched during use**. They can be built into the adaptor during assembly in the factory or added later without difficulty.

They are made from high performance polyethylene, which is anti-static and resists wear and tear.

Each adaptor has a corresponding interface:

SA103 for the SA003 adaptor

SA104 for the SA004 adaptor

SA105 for the SA005 adaptor

SA106 for the SA006 adaptor

SA107 for the SA007 adaptor



SA103



SA104



SA105



SA106



SA107

IMPORTANT

For your comfort and safety, please carefully read the instruction manual before using the portable valve actuator.

EXTENSION BARS

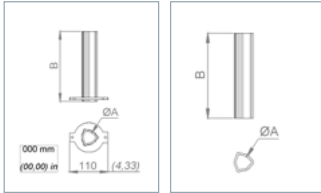

EBx02

EBx04

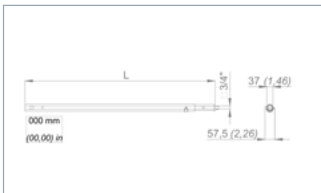

EB001 / EB002

We have a wide range of **extension bars** which enable operators to move away from the handwheel or valve, notably in the case of tapered handwheels and underground / buried valves. **Light and robust**, they can be used on **rising stems** up to a 48 mm maximum diameters.

The **EBX02** extension bars fix directly on to the **CSB** adaptors.

The **EBX04** extension bars fix on to the **FUA** adaptors using the **TTA** interface, or directly onto the FSB.

All the extension bars can connect to our actuators using the **TTA** interface **for the banjo heads** and the **KTA** interface **for straight and right angle heads** (See technical sheet 14).

The **EB00X telescopic extension bars** are specifically adapted for manipulating **underground / buried valves**. On one end they have a square $\frac{3}{4}$ " male connector that connects to a standard socket. They can be activated either by a **straight or right angle actuator**, or by an actuator with a **banjo head** (using the **KHA002** interface, see below). In case the valve is deep in the ground, one can use the **EB01X extensions** to the telescopic **EB00X**.

Reference	Weight kg (lb)	Max torque Nm (lb.ft)	"L" mm (in)	"A" mm (in)	Maxi stem Ø mm (in)
EB001	4,4 (9,7)	1000 (740)	1020-1726 (40) (68)	37 (1,46)	N/A
EB002	2,2 (4,9)	1000 (740)	570-940 (22) (37)	37 (1,26)	N/A
EB011	3,7 (8,2)	1000 (740)	1000 (39,4)	37 (1,46)	N/A
EB012	1,9 (4,2)	1000 (740)	500 (19,7)	37 (1,46)	N/A
EB202/EB204	1,3 (2,9)	1000 (740)	200 (7,9)	50 (1,97)	48 (1,89)
EB402/EB404	2,5 (5,5)	1000 (740)	400 (15,7)	50 (1,97)	48 (1,89)
EB602/EB604	3,7 (8,2)	1000 (740)	600 (23,6)	50 (1,97)	48 (1,89)

Reference	Interface for straight or right angle heads	Interface for Banjo head	Interface for adaptor	Type of adaptor
EB001/EB002	Direct	KHA002	Direct	DCxxx / CA $\frac{3}{4}$
EBX02	KTA002	TTA002	Direct	CSB
EBX04	KTA002	TTA002	Direct / TTA002	FSB / FUA

INTERFACES FOR TELESCOPIC VALVE KEY AND BJH

With the **KHA002** interface, you can manipulate the EB0xx extension bars (**telescopic valve keys**) with a banjohead.

Please note, this configuration cannot be used for handwheels with a rising stem.

Reference	Weight kg (lb)	Max torque Nm (lb.ft)
KHA002	0,9 (2,0)	1000 (740)

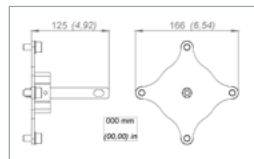

KHA002

IMPORTANT

For your comfort and safety, please carefully read the instruction manual before using the portable valve actuator.

INTERFACES FOR ADAPTORS FS, CS AND EXTENSION BARS

The **KTA** and **TTA** interfaces enable the actuators to drive the **FSB** and **CSB** adaptors, plus the **extension bars**.

The **KTA** models should be used for actuators with a straight or right angle head.

The **TTA** models fix directly on to the banjo head.



KTA002 (for straight or right angle heads)

TTA002 (for banjo heads)

Reference	Weight kg (lb)	«A» mm (in)	«B» mm (in)
KTA002	0,4 (0,88)	50 (1,97)	N/A
TTA002	0,4 (1,54)	52 (2,05)	95 (3,74)

Maximum allowed torque: 1000 Nm (740 lb.ft)

SQUARE DRIVES

The **KTA3/4** and **TTA3/4** interfaces can take a **3/4" square drive** which connects to **all types of socket** thereby turning all kinds of screws and bolts – this makes it possible to use your actuator for various types of applications.

The **KTA** models should be used for actuators with a straight or right angle head.

The **TTA** models fix directly on to the banjo head.

A large range of **standard square sockets** is also available to match most of the valves standards square drives

Reference	Weight kg (lb)	Max torque Nm (lb.ft)
KTA3/4	1,1 (2,43)	1000 (740)
TTA3/4	1,1 (2,43)	1000 (740)

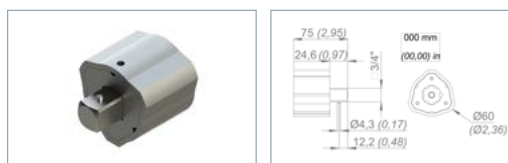

KTA3/4 (for straight or right angle heads)

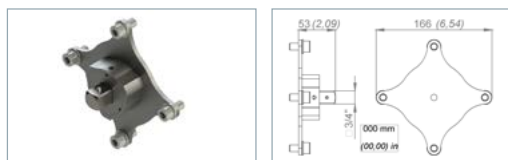

TTA3/4 (for banjo heads)

IMPORTANT

For your comfort and safety, please carefully read the instruction manual before using the portable valve actuator.

TORQUE REACTION MANAGEMENT SYSTEM

1/3

To guarantee operator **safety** and **comfort**, it's **essential** to use a **torque reaction management system**. Several types of system are available for use in different situations. Each is compatible with the whole range of actuators and adaptors because of their standard flange.

SINGLE AND DOUBLE REACTION ARMS

Our actuators are supplied with a **torque reaction arm** which enables the torque to be controlled by a strap attached to the end of the bar and to a fixed point in the working environment. In this way, **the operator is not exposed to the torque reaction**, in particular at the end of the process.

Reference	Weight kg (lb)	Max torque Nm (lb.ft)
BR001	3,5 (7,7)	1000 (740)
BR011	1,0 (2,2)	200 (150)
BR021	4,4 (9,7)	200 (150)
BR002	5,6 (12,3)	1000 (740)
BR003	3,4 (7,5)	1000 (740)



ARTICULATED REACTION ARM FIXED TO VEHICLE TRAILER HITCH

This **telescopic metal bar** can be easily positioned between a vehicle's trailer hitch and the actuator. Ideal for **valves buried beneath roads**, or for any valve which has an upward facing handwheel.

Reference	Weight kg (lb)	Max torque Nm (lb.ft)
BA001	12.3 (27,1)	1000 (740)

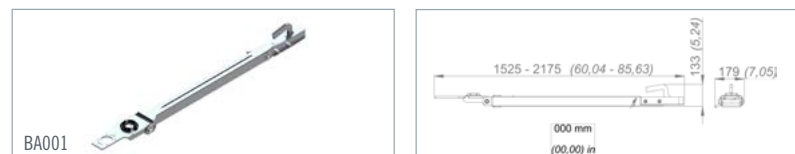

IMPORTANT

For your comfort and safety, please carefully read the instruction manual before using the portable valve actuator.

TORQUE REACTION MANAGEMENT SYSTEM

2/3

FOOT HELD ARTICULATED REACTION ARM

You don't need to attach this torque reaction system to anything – By simply standing on the reaction arm, the operator doesn't need to carry the torque reaction with his arms, his own weight does the job !

Reference	Weight kg (lb)	Max torque Nm (lb.ft)
BA002	5,3 (11,7)	350 (260)



BA002

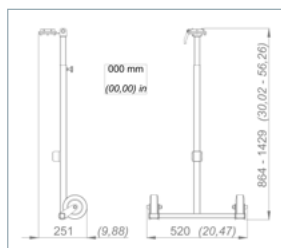

Example of use with a buried / underground valve.

STAND FOR UNDERGROUND / BURIED VALVES

Reference	Weight kg (lb)	Max torque Nm (lb.ft)
SE001	13,5 (29,8)	350 (260)

Designed for underground water distribution system valves, this stand makes the actuator easy and safe to use with a telescopic «Tee-key». Light and pliable, it's simple to transport with the two wheels, takes up minimal space and **can be erected in a couple of minutes** using just a few knurled screws.

Once in place, the stand – not the operator - bears the load of both the torque and the weight of the actuator.

It's the perfect tool for water distribution system operators.

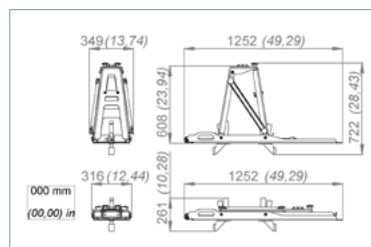

IMPORTANT

For your comfort and safety, please carefully read the instruction manual before using the portable valve actuator.

TELESCOPIC BIPOD

The bipod is **simple, small, easy to use and practical**. It's adapted for use in a wide variety of situations.

With its two telescopic legs and a flange that can be placed in **any position**, it redirects the torque without any difficulty into the ground, a wall or any other fixed point.

Reference	Weight kg (lb)	Max torque Nm (lb.ft)
BP002	12.3 (27.1)	1000 (740)



BP002

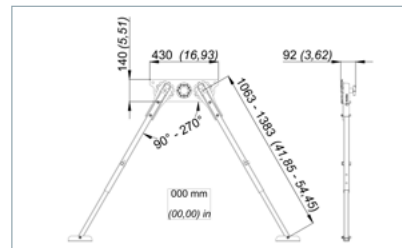

OTHER TORQUE REACTION SYSTEMS

These flanges are designed to be used with a **specific valve or system**. Before using it, you need to equip the valve with a fixed system on to which the actuator can be placed. Some of them therefore require some **preliminary design** but thereafter the flange is perfectly adapted to both the system and application. This flange is particularly useful for valves and systems that do not have a handwheel and need activating regularly.

These flanges are **made to order** by our technical department based on the specific characteristics of your system.



BS001

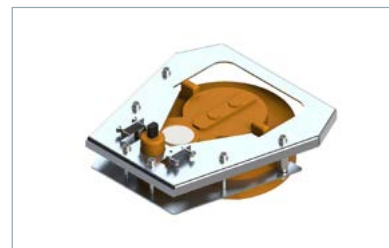

Special, made to order flanges

IMPORTANT

For your comfort and safety, please carefully read the instruction manual before using the portable valve actuator.

We have a range of accessories specifically for pneumatic portable actuators designed to improve user comfort as well as the protection of both operator and equipment.

AIR FILTRATION, PRESSURE REGULATION AND LUBRICATION UNITS

Pneumatic portable valve actuators (HL83) require **dry, clean** and **properly lubricated air** in order to work effectively. The FRL unit filters, dries and lubricates the compressed air, guaranteeing that the motor operates as required. It also controls the air supply pressure, which in turn controls the actuator's performance (maximum torque).

The FRL should be positioned **less than 5 meters away from the tool**. When selecting the FRL, check that it has a flow capacity suitable for the actuator's requirement.

modec offers a complete range of FRL units that are compact, robust, adapted to the constraints of work sites and easy to connect. A **connection kit** between the FRL and the actuator is available (ref **AC051**) with a quick connector for more comfort.

Self-relieving regulator. Lubrication with selective oil fog. Metal bowl with oil level viewing window.

Automatic oil tank fill-in system

Recommended oil type : MODEC Co-16 oil (reference **AC149**).

Reference	AC107
Max inlet pressure (23°C / 50°C)	16 / 10 bars 232 / 145 psi
Pressure gauge	0 / 10 bars 0 / 145 psi
Controlled pressure	0,5 / 8 bars 7 / 116 psi
Ambient temperature	0 à +50°C 0 / 122°F
Oil bowl capacity	80 cm ³ 0,003 cfm
Filtration	5 µm
Purge system	Semi-auto
Connection	G ½
Dimensions	271 x 167 x 112 mm 10,7 x 6,6 x 4,4 in
Weight (empty)	2,9 kg / 6,4 lb

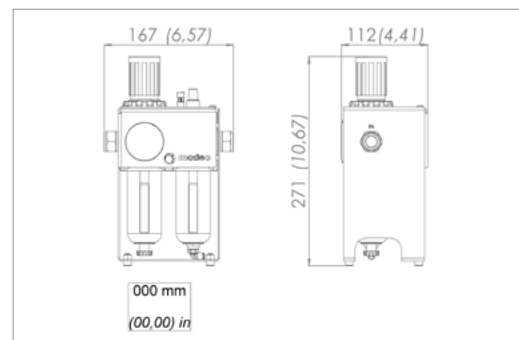

IMPORTANT

For your comfort and safety, please carefully read the instruction manual before using the portable valve actuator.

We have a range of accessories specifically for pneumatic portable actuators designed to improve user comfort as well as the protection of both operator and equipment.

SAFETY AIR TREATMENT BOX (SAT BOX)

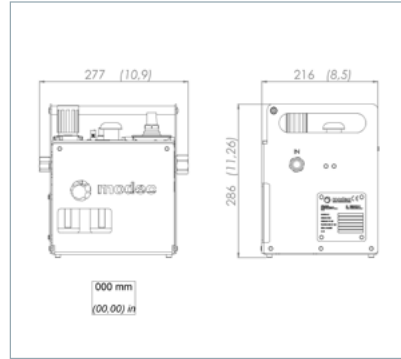

The **SAT Box** (Safety Air Treatment box) is a **safety device** that protects the user and the equipment.

The **SAT Box** provides numerous important safety features:

- Emergency kill switch
- Key safety lock (optional)
- Downstream automatic air-bleed
- Automatic switch off when air pressure drop detected

Reference: AC118

Reference	AC118
FRL Type	AC107
Emergency kill switch	YES
Automatic downstream air bleed	YES
Pressure gauge	0 / 10 bars 0 / 145 psi
Filtration	5 µm
Oil bowl capacity	80 cm ³ / 0,003 cfm
Connections	input : G ¹ / ₂ / output : G ³ / ₄
Min & max inlet pressure	2 / 8 bars 29 / 174 psi
Dimensions	277 x 216 x 286 mm 10,9 x 8,5 x 11,3 in
Weight (empty)	7.6 kg / 16,8 lb
Ambient temperature	0 / +50 °C 0 / 122 °F

Those Safety devices ensure an instantaneous air bleed in the downstream circuit when the emergency kill switch is hit and/or when air supply stops. As a consequence, no residual energy may create an accidental motion after the stop. All these safety features are energized by air pressure, without any other source of energy required.

If the air feed pressure falls below 2 bars, the SAT box will automatically shut down in order to prevent the actuator inadvertently restarting if the pressure climbs back up (if the compressor stops and then restarts for example).

All of these functions are operational with the air supply pressure - there's no need for another energy source.

Finally, the SAT box integrates the FRL unit (Filtration, air pressure Regulation and Lubrication) in order to ensure that the air feed is clean and correctly lubricated.

A **connection kit** between the SAT Box and the actuator is available (ref **AC052**) with a quick connector for more comfort.

EXHAUST COLLECTOR AND SILENCER

It is recommended to use a **silencer** with pneumatic portable actuators. It fixes to the actuator's exhaust vent and **reduces the sound level**. We have silencers of varying sizes and performance levels for different applications and constraints of use of the actuators.

> **Heavy duty exhaust silencers**: Extremely robust and compact, this stainless steel silencer reduces the noise level and protects against foreign bodies getting into the motor via the exhaust vent.

References: AC155 for Easy Duty actuators

AC156 for Standard Duty and Heavy Duty actuators

> **High flow exhaust silencer**: Constructed with a unique expansion chamber, completely free of obstruction, exhaust air softly flows to the atmosphere with significant noise and oil fog reduction, providing a clean comfortable productive work environment. Composed entirely of corrosion-resistant material for long life and maintenance-free performance, this model is especially recommended for Standard Duty and Heavy Duty actuators.

References: AC159 for Standard Duty and Heavy Duty actuators only

> **The exhaust collector** must be assembled on Standard duty and Heavy duty actuators radial exhaust to accommodate the silencer. For Easy duty actuators, the silencer can be directly fixed to the exhaust vent at the back of the motor.

IMPORTANT

For your comfort and safety, please carefully read the instruction manual before using the portable valve actuator.

To maintain optimum performance and durability, your pneumatic portable actuator needs to be stored in the right conditions. We have two types of box for storing and transporting actuators and their accessories.

As well as providing protection, these boxes are also ideal for transporting all the equipment to sites and minimizing the risk of misplacing any parts.

▶ TRANSPORT CASES



Extremely robust, with wheels and handles, these transport and storage cases are **designed to order** so that all the equipment fits snugly into **a thick, pre-cut protective foam**.

Available in five sizes, the cases are adapted to accommodate the required equipment by cutting the protective foam to measure.



Dimensions	VT001	VT002	VT003	VT004	VT005
Length mm (in)	1200 (47,2)	860 (33,9)	305 (12,0)	630 (24,8)	670 (26,4)
Height mm (in)	420 (16,5)	560 (22,0)	270 (10,6)	500 (19,7)	510 (20,1)
Width mm (in)	234 (9,2)	355 (14,0)	194 (7,6)	370 (14,6)	262 (10,3)

▶ «MODEC KIT BOX»



For **regular professional use**, the **modec kit box** is a metal case that can hold all the equipment necessary for various operations (actuators, adaptors, torque management systems, batteries, chargers, FRL unit, air feed pipes etc). With the kit box, you can transport all the equipment to the work site **without difficulty** and **get started quickly and simply**.

The Kit box can be positioned vertically or horizontally and comes with 2x3 wheels so it can be easily moved around, even up and down stairs. The interior has compartments so the different parts can be stored easily and efficiently, and, more importantly, can be put together quickly.

In the case of a pneumatic actuator, for example, it can hold the FRL unit and an air feed pipe on a reel.

Once again, the **modec kit box** can be modified to order and **adapted to your needs**.

References : VT006

A photograph of an industrial facility featuring a complex network of blue and yellow pipes. Two prominent yellow handwheels for valves are in the foreground. The scene is lit with a cool blue light, and the floor is highly reflective, mirroring the pipes and valves above. The overall atmosphere is technical and industrial.

ADAPTORS SELECTION GUIDE

FLAT HAND WHEEL WITH OR WITHOUT RISING STEM

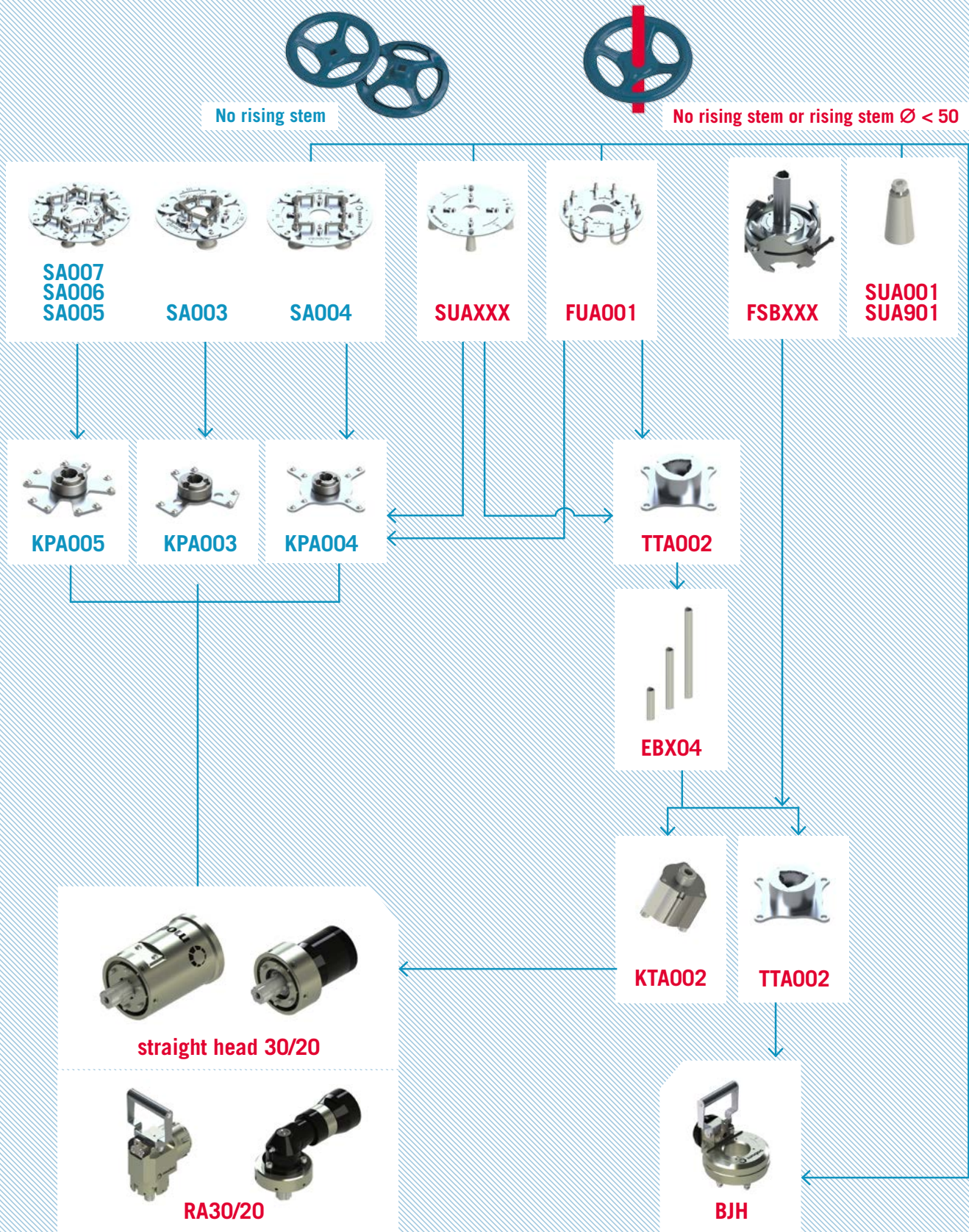

DEEP HAND WHEEL WITH OR WITHOUT RISING STEM ($\varnothing < 50$ MM)



OTHER TYPES OF VALVE SHAFT

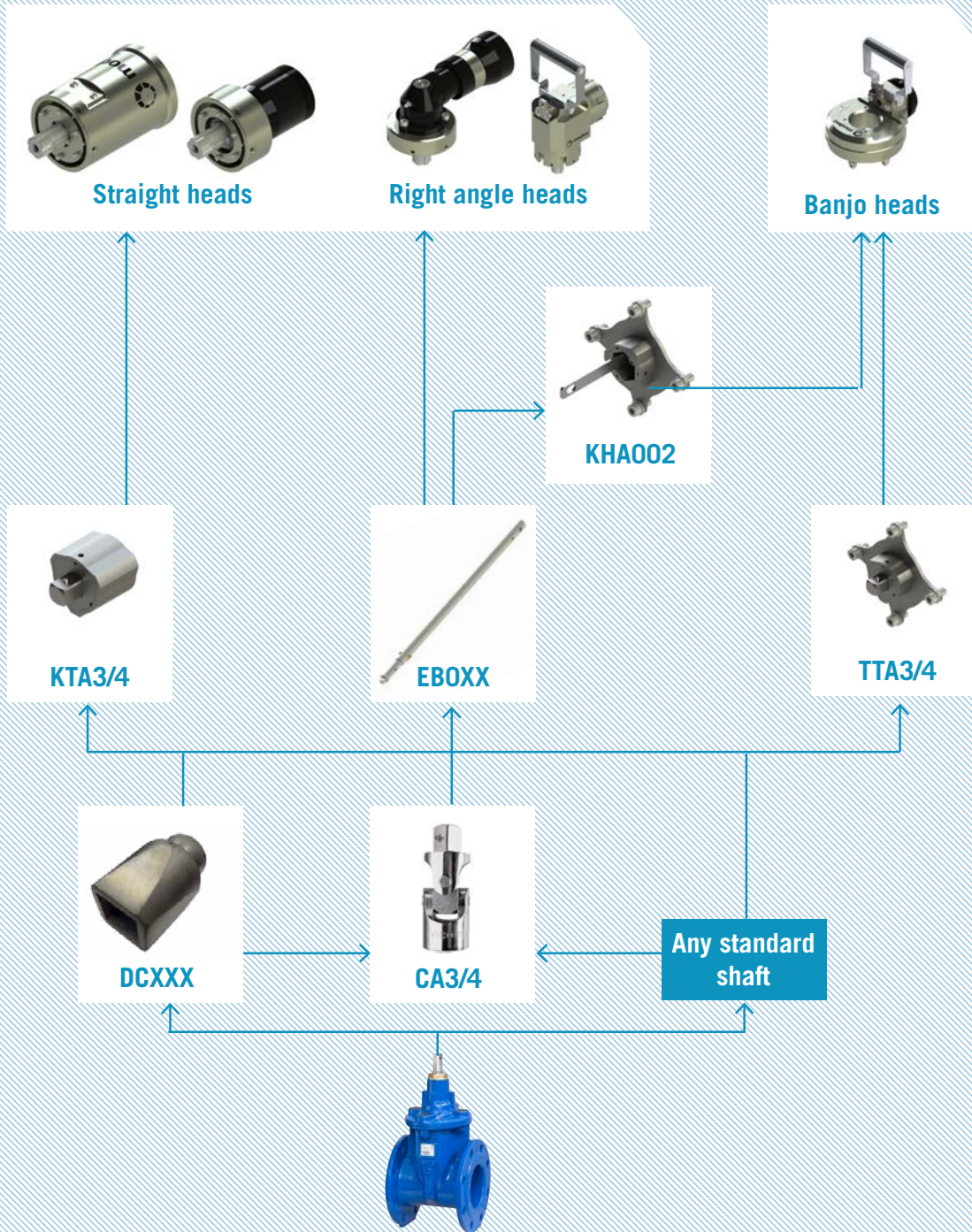

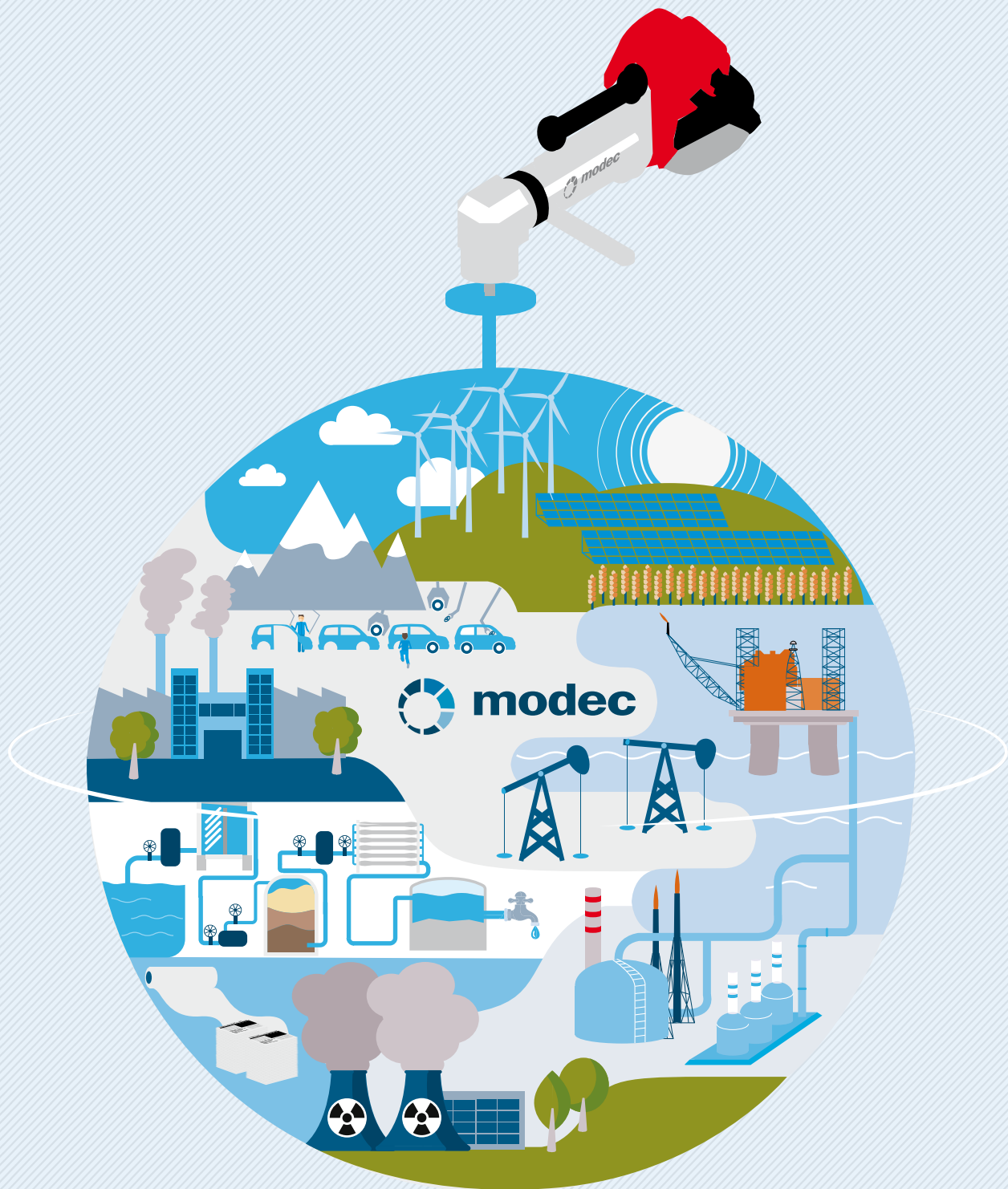

MODEC USA Inc.

185 Alewife Brook Parkway
Suite #210
CAMBRIDGE, MA 02138
U.S.A.

Mail : sales@modec.fr

Phone : +1 (617) 858 7194

www.modec.fr

Your local Modec distributor